

PLYWOOD 12mm
L= 2400x1200

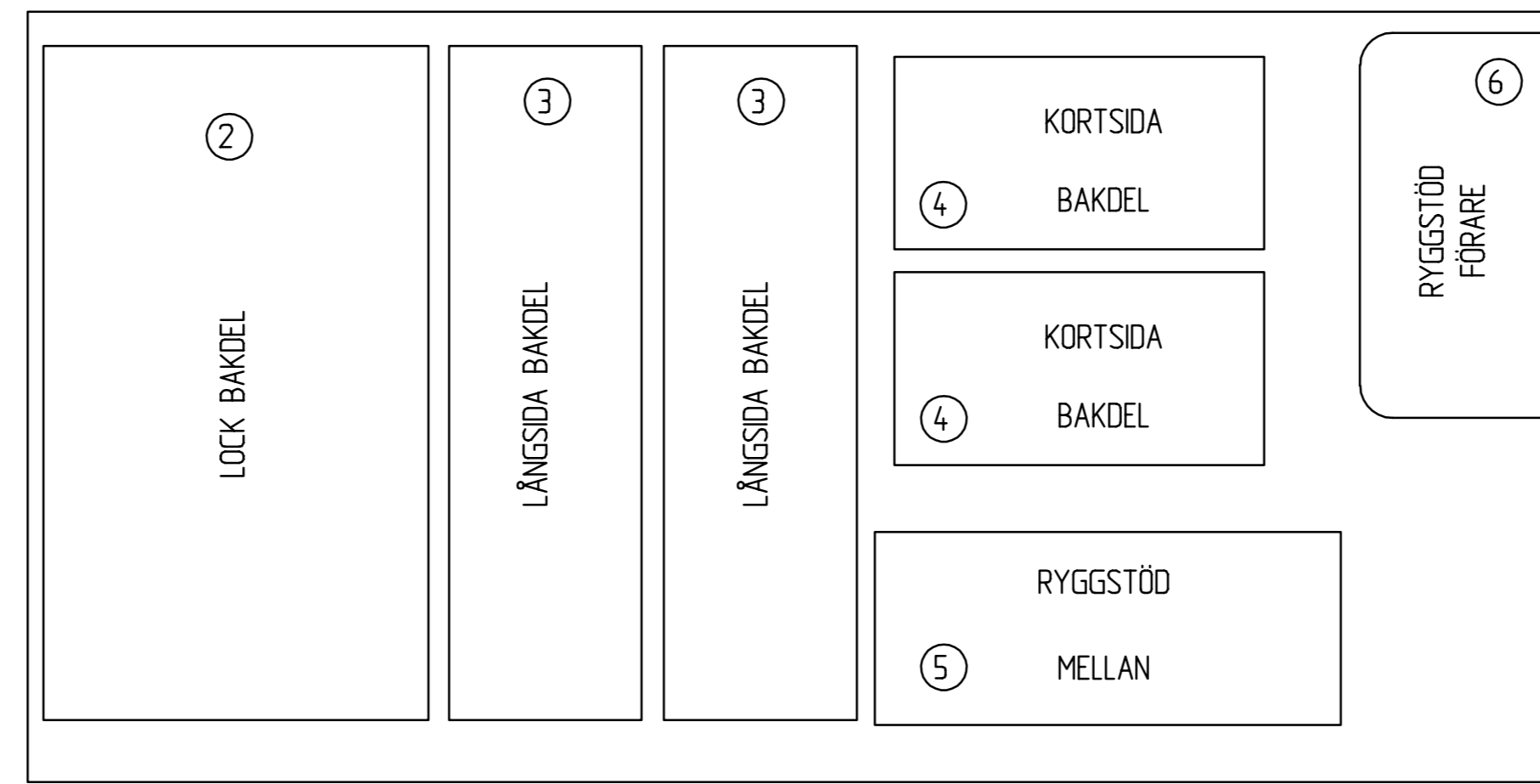

PLYWOOD 12mm
L= 2400x1200

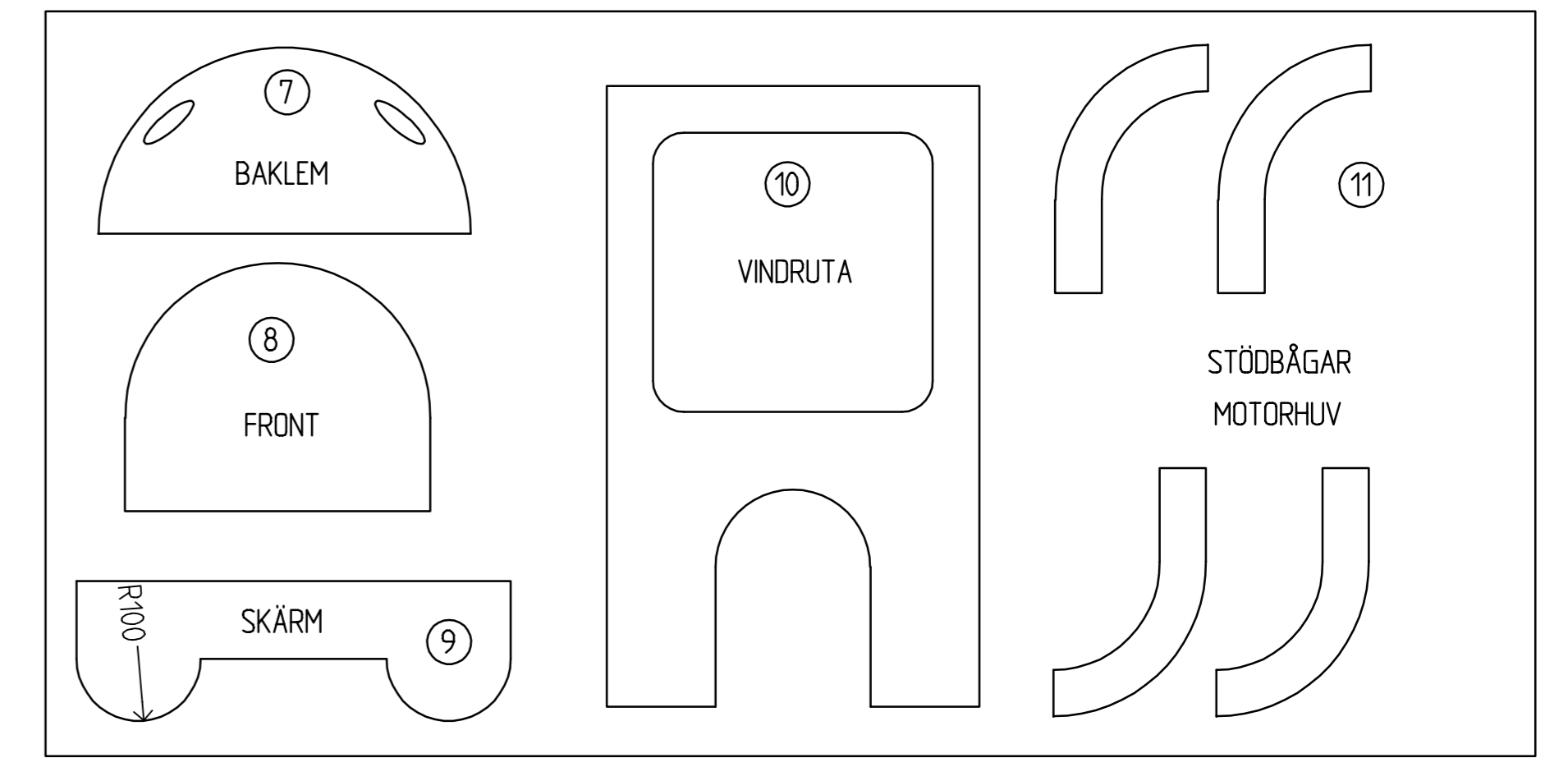

PLYWOOD 12mm
L= 2400x1200

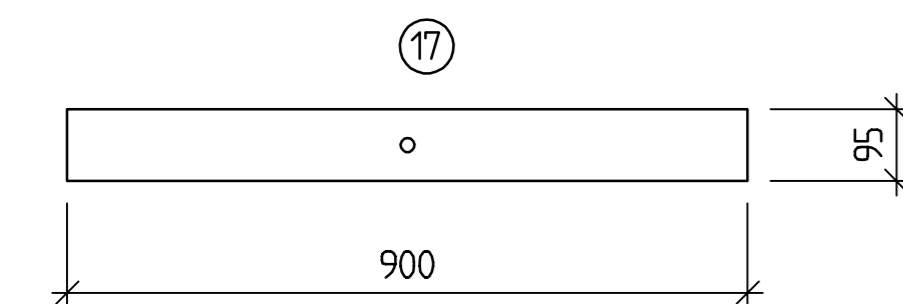
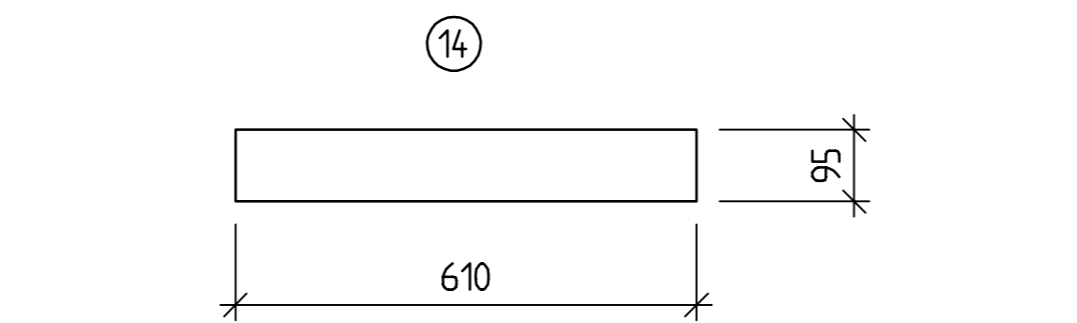
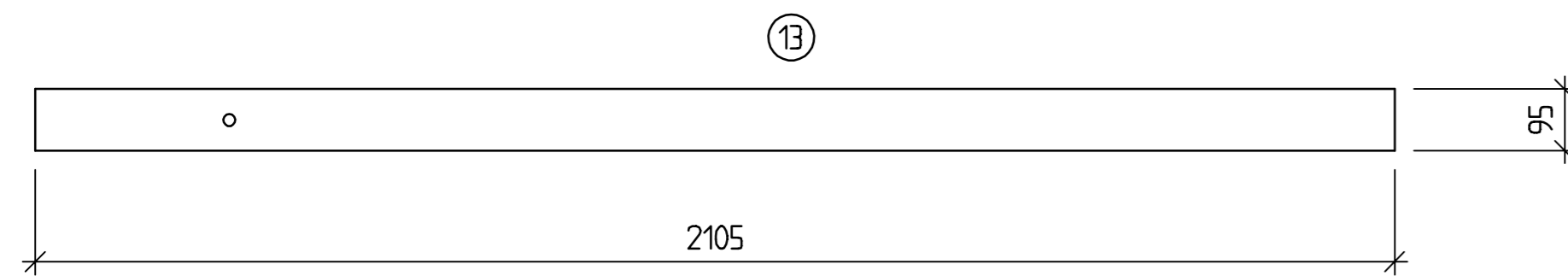

BAKAXEL

REGEL 45x95 L=3600 AN TAL 3ST

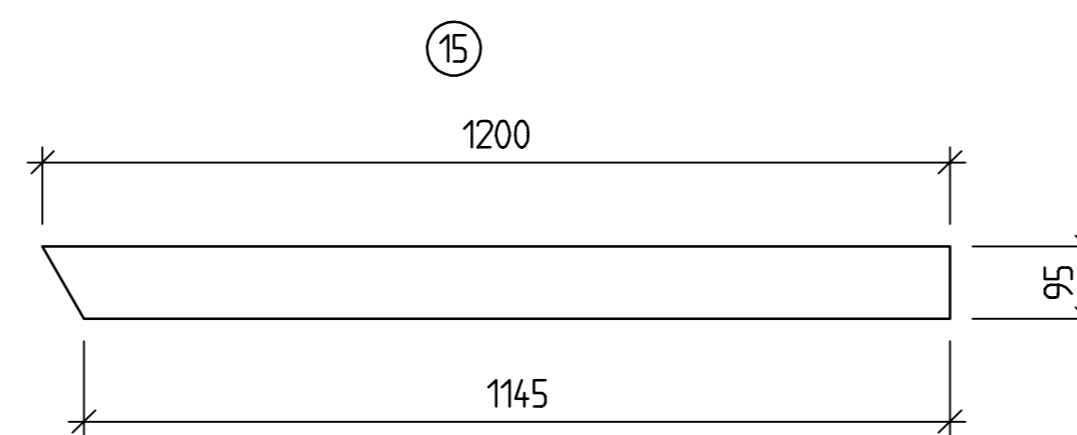

ANTAL 2 ST

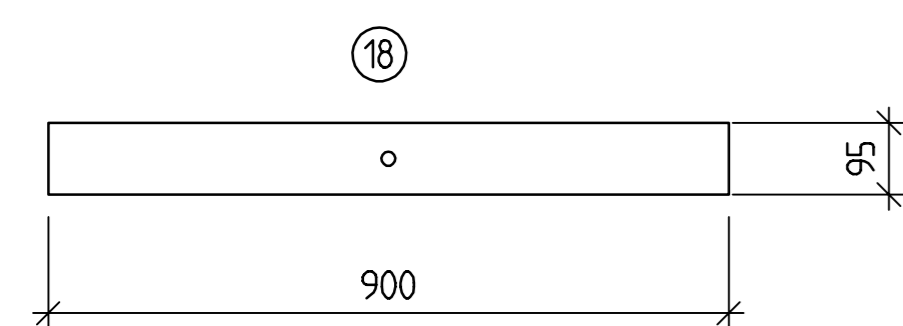

FRAMAXEL

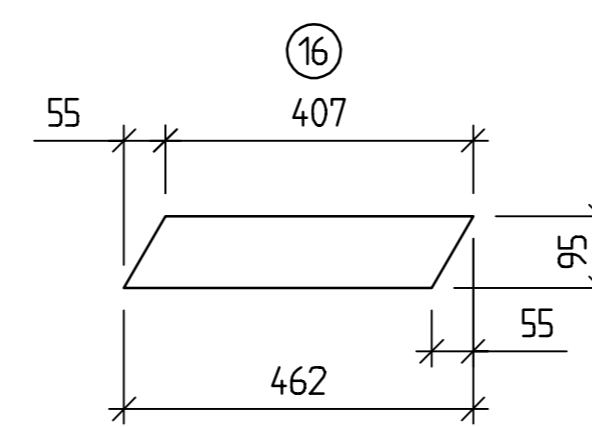

ANTAL 2 ST

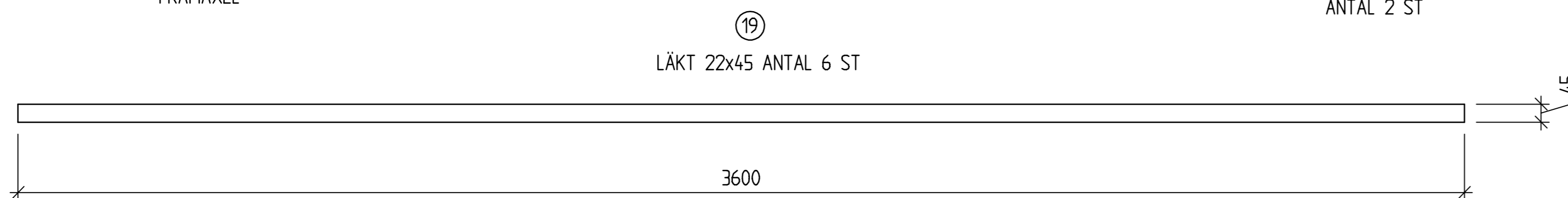

LÄKT 22x45 AN TAL 6 ST

SKALA 1:10

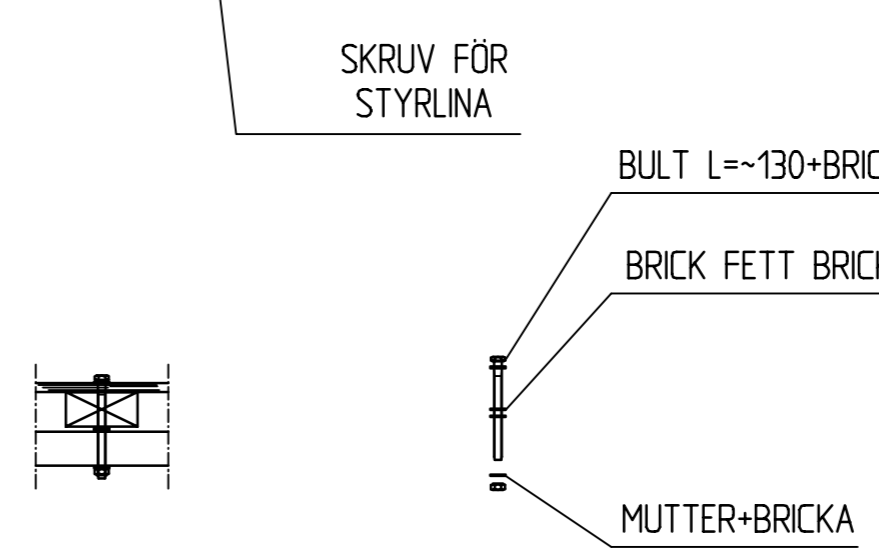
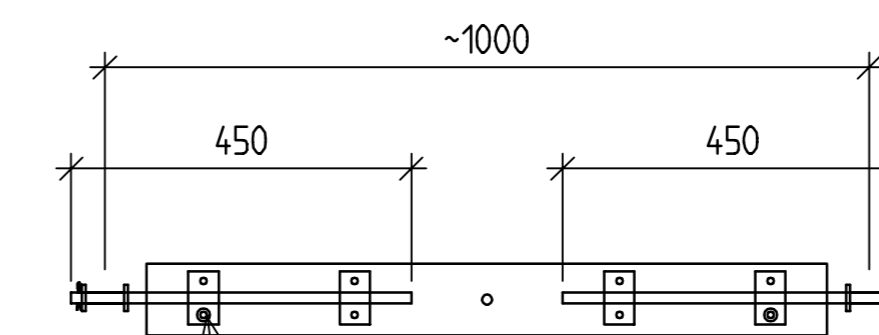
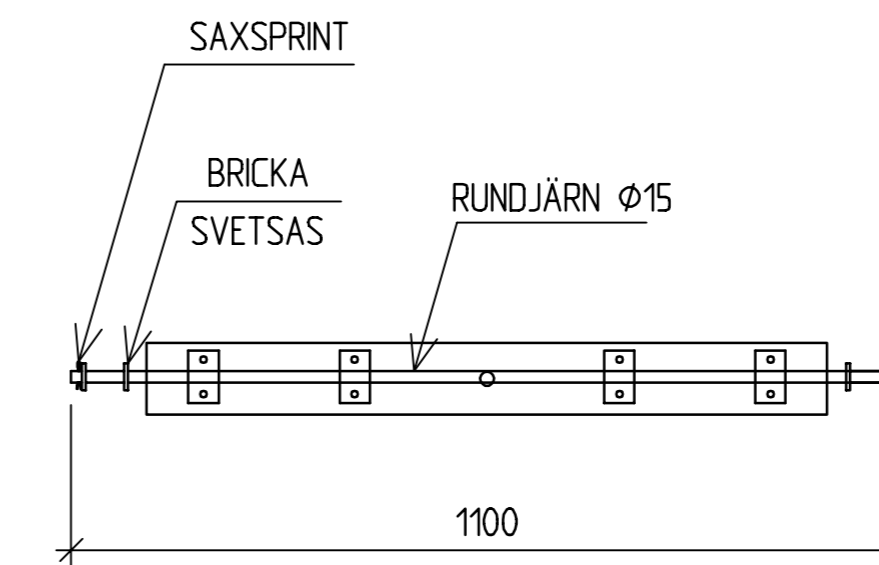

STYRNING

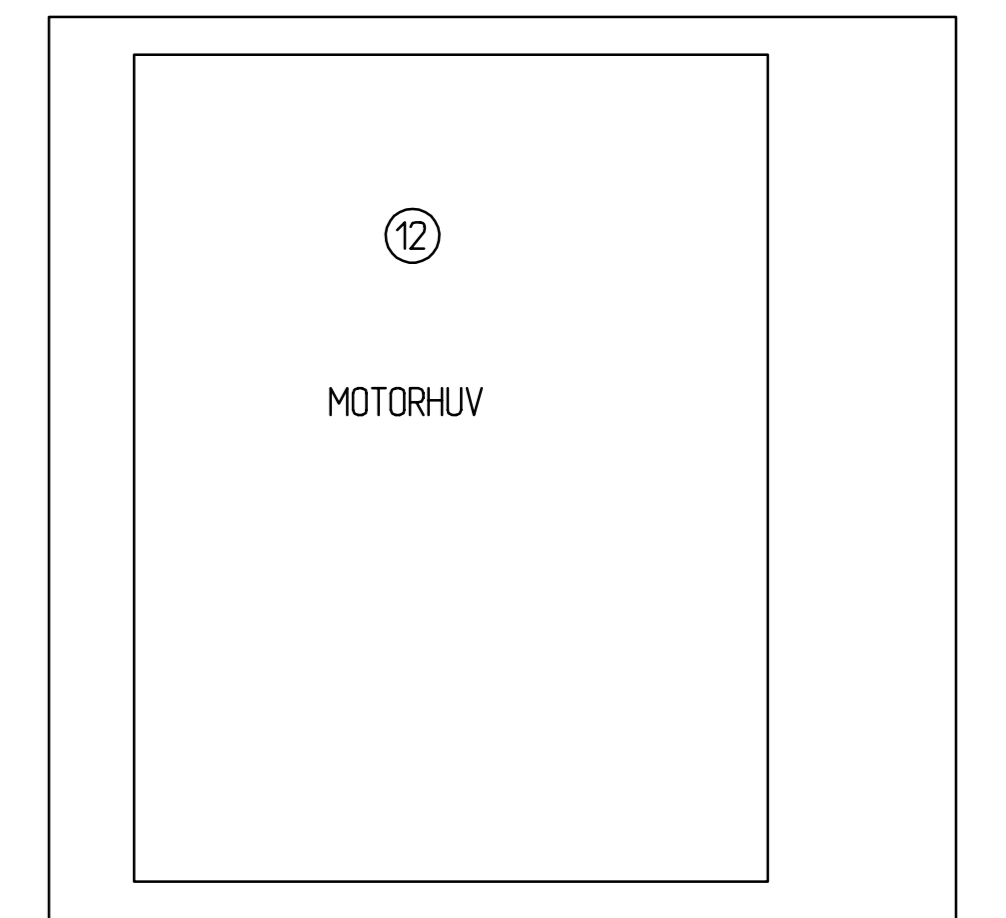

PLYWOOD 4 mm
L= 1200x1200

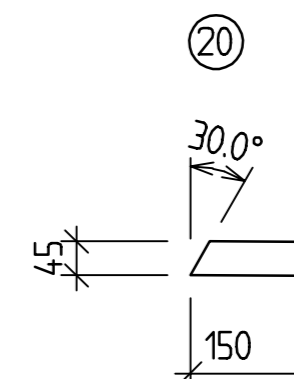
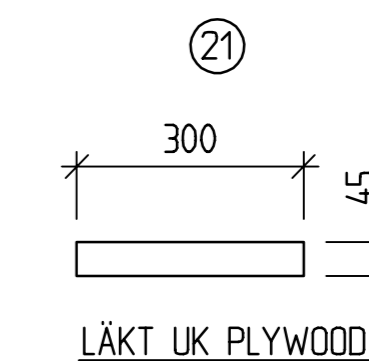

BET	ANT	ÄNDRINGEN AVSER	DATUM	SKEN

BARNENS BYGGSKOLA NCC

NCC NCC TEKNIK
205 47 Malmö
Tfn 040-31 70 00
Besöksadress:
Thomsons väg 40

UPPDRAG NR	RITAD AV / KONSTR AV	UPPDRAGSLEDARE
	ML / ML	L. TENGVALL
DATUM	ANSVARIG	
050512	LARS TENGVALL	
TILLVERKNING AV LÅDBIL "BRANDBIL"		

NCC NCC CONSTRUCTION
205 47 Malmö
Tfn 040-31 70 00
Besöksadress:
Thomsons väg 40

PLAN, SEKTIONER OCH DETALJER	NUMMER	I BET
SKALA A1: 1:10 A3: 1:20	K-02	